Operation Manual

FLETA 40P

Clinical Centrifuge

Date of Purchase	
Serial No.	
Place of purchase	

Fleta 40P

Medical Device

Copyright © 2018 Hanil Scientific Inc. All rights reserved.

Contact Us

If you have any questions, contact Hanil Scientific Inc. or place of purchase.

+82-2-3472-0727

Inquiry: info@ihantil.com

Order: sales@ihantil.com

Tech. support: techsupport@ihantil.com

The contents in this operating manual are subject to change for device improvement.

CONTENTS

1. General Considerations-----	3
1.1 Safety -3	
1.2 Transport & Storage -4	
1.3 Safety label -4	
1.4 Electric safety information -4	
2. Product description-----	5
2.1 Structure -5	
2.2 Delivery package -5	
2.3 Technical specifications -6	
3. Installation -----	7
3.1 Packing Inspection -7	
3.2 Installation -7	
3.2.1 Selecting the location -7	
3.3 Power connection -8	
4. Operation -----	9
4.1 Operation panel -9	
4.2 Opening and closing the lid -10	
4.3 Loading/Unloading a rotor - 11	
4.4 Loading tubes - 12	
4.5 Setting Rotor Id. - 13	
4.6 Setting RPM/RCF - 13	
4.7 Setting Run Time -13	
4.8 Setting Accelation/Deceleration rate -14	
4.9 Start/Stop -14	
4.10 Saving/Calling up a program -15	
5. Maintenance-----	16
5.1 Care instructions -16	
5.2 Cleaning -16	
5.3 Disposal-17	
6. Troubleshooting-----	18
6.1 General errors -18	
6.2 Error codes -19	
6.3 Emergency lid open -21	
7. Rotor -----	22

1. General Considerations

1.1 Safety

Follow precautions and all the safety requirements described on this user manual to prevent any damage and failure of equipment and loss of lives.

1. The centrifuge should be installed on flat surface to maintain level.
2. Check the voltage to be used, before connecting the centrifuge to the power source.
3. Only use rotors, parts, and accessories provided by Hanil Scientific Inc.
Hanil Scientific Inc. is not responsible for damages of the device and accidents caused by using parts and accessories not recommended.
4. Do not exceed the maximum rated speed of the rotor or buckets in use.
5. Make sure to prepare necessary safety measures before using samples that are toxic or radioactive samples or pathogenic or samples or infectious blood.
6. Substances that may generate volatile or explosive vapor can not be centrifuged.
7. The balancing work of samples should done in advance before operation.
8. To ensure safe use of the device, do not expose the device to strong acids, strong bases, cesium, salt, or alkaline detergents.
8. If the centrifuge is contaminated by toxic or radioactive samples or infectious blood samples, remove contaminants completely and take needful actions such as ventilation or isolation of centrifuge.
9. Before operation, rotor and chamber should be dry.
10. Do not attempt to slow or stop the spinning rotor by hand.
11. Only centrifuge with rotor and rotor lid firmly tightened.
12. Do not block vents.
13. When serving the centrifuge, be sure to remove contaminants in advance.
14. Please contact the place of purchase or Hanil Scientific Inc. for product repairs.
15. According to IEC61010-2-020 maintain a 30cm “clearance envelope” around the centrifuge while the rotor is spinning.
16. Turn the power switch off after using the device.
17. Unplug the power plug before cleaning or left unused for a long period of time.

1. General Considerations

1.2 Transport & Storage



- The device and the accessories may only be stored in dry rooms

-Storage-

Ambient temperature 5°C~40°C

Maximum relative humidity 30%~85%

Air pressure 500~1060hpa



- Only lift and transport the device with sufficient number of helpers.

-Transport-

Ambient temperature -10°C~40°C

Maximum relative humidity 10%~90%

Air pressure 500~1060hpa

1.3 Safety label attached to a product



Insert tube symmetrically.

Firmly tighten the rotor lid.

Watch your fingers when close the lid.



Mark indicating danger and warning.



Mark indicating a place in danger of electric shock.



Mark indicating earth grounding

1.4 Electric safety information

1. It is recommended that switchgear or circuit breakers and overcurrent protection devices be installed near the equipment.
2. Use a power cord only provided with equipment.
3. Use sockets with a protective earth conductor and suitable power cord.
4. Do not use an extension cord.
5. Do not place anything on the power cable
6. Do not block vents.
7. If you have the following emergencies, shut off the power supply and unplug the power cord from outlet and contact your place of purchase.
 - Unusual noises or smell from the equipment.
 - Damage or wear of a power cord.
 - Breakdown of circuit breaker, fuse or safety device.
 - If you spill liquid on the equipment.
 - If the device has been damaged.

2. Product description

2.1 Structure

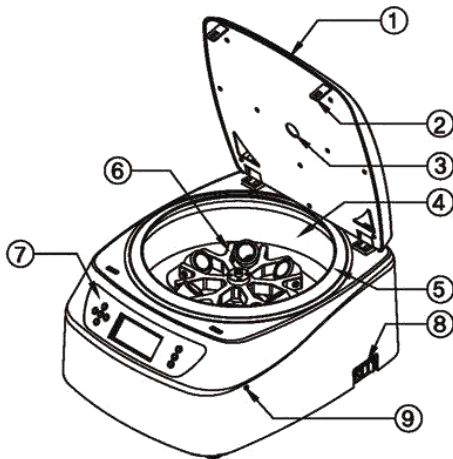

- ① Lid
- ② Lid Latch
- ③ RPM measuring window: Visual inspection for rotor stop or for a speed check using a tachometer.
- ④ Chamber: Where the rotor is loaded.
- ⑤ Lid Packing
- ⑥ Rotor
- ⑦ Display&Control panel: The display shows time, rpm, temperature and etc.
- ⑧ Power switch & Power socket : On/off the centrifuge.
- ⑨ Emergency Release Hole:
If the centrifuge lid cannot be opened, you can open the lid manually.(see 21p)

2.2 Delivery package

- ① Main body
- ② Power Cable
- ③ Operating manual
- ④ Optional items: Rotors

2. Product description

2.3 Technical Specifications

Max. RPM	4,000 rpm
Max. RCF	3,243 xg (Swing) 2,789 xg (Fixed angle)
Max. Capacity	6 x 50 mL, 12 x 15 mL conical, 4 x 85 mL (Swing) 24 x 15ml (Fixed angle)
Time control	< 100 min, pulse, continuous
ACC/DEC ramps	5/6 steps
Program memory	10
Noise level	< 60 dB
Imbalance cutoff	Yes
Rotor identification	Manual
Dimension (W x D x H, mm)	448.5 x 531 x 286
Weight without rotor	25 kg
Power requirement (VA)	500 VA
Power input (V, Hz)	210~240 V, 50/60 Hz (110V optional)
Cat. No.	FL-40P

3. Installation

3.1 Packing Inspection



- Check packing conditions carefully, before unpacking.
- Contact Hanil Scientific Inc. immediately if damages found.
- Check the delivery for completeness.

- You can get contact details on packing boxes and the back of the manual.

3.2 Installation

3.2.1 Selecting the location

Installation on hard and flat ground.

- Centrifuge should be installed on hard and flat place.
- If the centrifuge is installed in an inclined place, the shaft may be bent due to the weight of the rotor.

Goodventilation.

- For air circulation and safety, maintain a 30cm “clearance envelope” around the centrifuge while the rotor is spinning.

Constant temperature/humidity

- Centrifuge equipped with the sensitive electronic software which is fragile with humidity and temperature.
- Must avoid direct ray or heater and be put in the ambience of controlled temp. and air.

Avoid the corrosive gas

- Install the centrifuge in a place where corrosive gas is not generated.
- Sulfur dioxide gas and chlorine gas may cause corrosion.

Leveling

- The shaft should be put exactly vertical on the horizontally flat ground by the leveling tool

3. Installation

3.3 Power Connection









- Connect the device to voltage sources, which correspond to the electrical requirements on the label attached to the device.
- Check the wall outlet is earth-grounded, surge-protected and can supply enough power.

1. Connect the DC plug at the power socket on the right side of the device.
2. Plug the AC plug into the outlet.
3. Turn on the power switch

4. Operation

4.1 Operation Panel



Button		Description
	Setup / Enter	Set the Values
	UP / Down	Up or down the values
	Move(Left/Right)	Select a parameter
	Start/Stop/Short	Start/Stop the centrifugation Press more than 2sec. : short spin
	Lid	Lid open
	Program	Press once: Saving a program (Up to 10) Press twice: Calling up a program

4. Operation

4.2 Opening/Closing the lid



- The lid can only be opened if the centrifuge is switched on.
- Do not reach with your fingers between the housing and lid.
- Close the lid completely before operation.

Opening the Lid

1. Press the Lid button().

Closing the Lid

1. Put the lid on and press the edge of the lid.

4. Operation

4.3 Loading/Unloading a rotor



- Only use rotors, parts, and accessories provided by Hanil Scientific Inc.
- Do not use scatched or cracked rotor in use.

Loading

- ① Clean the motor shaft and the chamber.
 - When loading the rotor, the temperature should be 10 to 30 degrees.
- ② Load the rotor vertically onto the motor shaft.
- ③ Insert the wrench into the center hole of the rotor and turn it clockwise to fasten the rotor bolt.
- ④ Check the rotor to make sure it loaded firmly.

Unloading

- ① To remove the rotor insert the wrench into the center hole of the rotor and turn it counterclockwise to loosen rotor bolt.

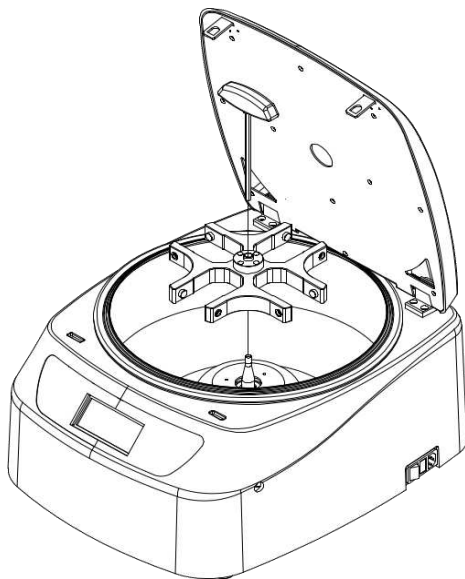

4. Operation

4.4 Loading tubes



- Only use tubes provided or approved by Hanil Scientific Inc.
- Always use the same type of tube.
- Tubes should be loaded symmetrically.
- Do not exceed the maximum rated speed of the tube.
- Same volume of sample should be put on tubes.
- Check symmetric loading by balancing tubes with scales.

- ① Check the maximum load for each tube.
- ② Put tubes into rotor holes.
- ③ Tubes located opposite each other must be the same type and contain the same quantity.

Correct arrangement

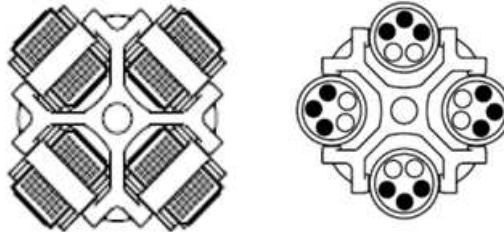



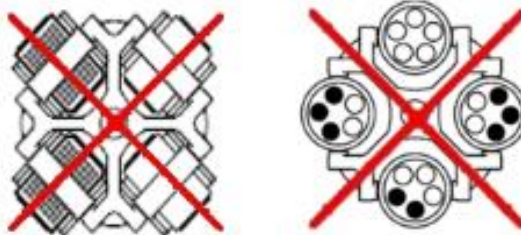



Wrong arrangement









4. Operation







4.5 Setting Rotor Id.

1. Press the Setup/Enter () button.
2. Press the Left() or Right() button to select rotor Id. mode.
 - ▶ Rotor Id. setting mode : Rotor flashes on display
3. Press the up() or down () buttons until the desired rotor id displayed.
4. Press the Setup/Enter () button.
 - ▶ You can check the rotor Id. [7. Rotors]

4.6 Setting RPM/RCF







1. Press the Setup/Enter () button.
2. Press the Left() or Right() button to select RPM mode or RCF mode.
 - ▶ RPM setting mode : RPM flashes on display
 - ▶ RCF setting mode : RCF flashes on display
3. Press the up() or down () buttons until the desired RPM/RCF is displayed.
4. Press the Setup/Enter () button.

4.7 Setting Run Time

1. Press the Setup/Enter () button.
2. Press the Left() or Right() button to select Time mode.
 - ▶ Min. setting mode : 00' flashes on display
 - ▶ Sec. setting mode: 00" flashes on display
3. Press the up() or down () buttons until the desired run time is displayed.
4. Press the Setup/Enter () button.

4. Operation

4.8 Setting Accelation/Deceleration rate

1. Press the Setup/Enter () button.
2. Press the Left() or Right() button to select Aceel / Decel mode.
 - ▶ Accel setting mode : accel flashes on display
 - ▶ Decel setting mode: decel flashes on display
3. Press the up() or down () buttons until the desired Accel/Decel step is displayed.
4. Press the Setup/Enter () button.

4.9 Start/Stop/Short Spin

Starting a centrifugation

1. Check the all parameters are correct and the lid is closed.
2. Press the Start () button.
 - ▶ If the lid is not closed, it will not start.

Stopping a centrifugation

1. Press the Stop () button to stop a centrifugation.





Short spin

1. Set the desired speed.[Refer to 4.5 Setting RPM/RCF]
2. Press the Start() button more than 2sec.





4. Operation

4.10 Saving/Calling up a program

Saving a program

- ① Set the centrifugation time/speed/Accel/Decel values.
- ② Press Program () button once.
 - ▶ You can store 10 programs on the device: 0~9
- ③ Select the program number by pressing the Up() or Down() button.
- ④ Press the Enter () button.

Calling up a program

- ① Press the Program () button twice.
- ② Select the program number by pressing the Up() or Down() button.
- ③ Press the Enter () button to call up a program.

5. Maintenance

5.1 Care instructions

- The following procedures should be performed regularly.
 - ① Regularly inspect the rotor chamber for check the motor shaft is normal.
 - ② Rotate the shaft with your hand to make sure it turns smoothly
 - ③ Use the stopwatch to check that the time setting is correct
 - ④ If you find any damages, do not use the device. Contact Hanil Scientific Inc.

5.2 Cleaning



- Before cleaning the centrifuge, be sure to switch off the device and disconnect the power cord.

- Outside of the device

- ① Clean the outside of the device with a soft and dry cloth.
- ② Do not use aggressive chemicals on the device such as alcohol, benzene, acetone or phenol.
- ③ If the device is contaminated, use a mild cleaning fluid to clean.
- ④ Make sure do not scratch the surface of equipment when cleaning it.
 - ▶ Do not use a metal sponge.
 - ▶ If the device is rusted, remove it with a mild detergent and wipe it with a dry cloth.

- Chamber

- ① If the rotor chamber is not dry, wipe moisture from the chamber with a dry cloth.
- ② Clean the chamber, motor shaft at least once a week using a mild cleaning fluid.

- Rotor

- ① To prevent corrosion, take out the rotor from the rotor chamber.
- ② If any sample is spilt inside the rotor, wash and dry the rotor well.

- ▶ If you have any questions about cleaning your device, please contact us.

5. Maintenance

5.3 Disposal

In case of product is to be disposed of, the local wastes laws and regulations are to be observed.

6. Troubleshooting

6.1 General errors

Problem	Recommended Action
Power failure	Check the power cord connection. Check the power fuse of the device.
Device cannot be started	Check the lid is closed completely.
Lid cannot be opened	Press the 'Lid open button'.
Lid cannot be closed	Remove the dirt at the door latch and close the lid. Check the lid latch is not damaged.
Unusual noise and vibration	Check the device whether it is installed on the hard and flat place
	Reload the rotor symmetrically. Reload the tubes symmetrically. Tighten the clamping of the rotor with wrench by turning clockwise

6. Troubleshooting

6.2 Error codes

Error code	Error message	Cause	Recommended action
E1	Imbalance error	- When an imbalance is detected	- Check weight-balances of samples and then turn off and on the device for checking.
E2	Over speed error	- over speed than set speed	- Shut off the power supply, and then, turn on the power switch again to check the device. - If the error code shows continuously although you try to operate again, please call please call Field Service Engineer.
E3	Motor overheat	- Motor overheat	- Shut off the power supply, and then, turn on the power switch again to check the device.
E4	Motor operation error	-Motor operation error	- Check that the rotor is rotating through the RPM measuring window - Shut off the power supply, and then, turn on the power switch again to check the device.
E5	Lid open(Operating)	- Lid open during operation	- Shut off the power supply, and contact Hanil Scientific Inc.
E7	System error	- System error	- Contact Hanil Scientific Inc.
E11	Motor temperature sensor error	Motor temperature sensor error	- Shut off the power supply, and then, turn on the power switch again to check the device.

6. Troubleshooting

6.2 Error codes

Error code	Error message	Cause	Recommended action
E12	Hi voltage error	- Hi voltage	- Shut off the power supply, and then, turn on the power switch again to check the device.
E13	Low voltage error	- Low Voltage	- Contact Hanil Scientific Inc.
E15	RPM Sensor error	- RPM Sensor error - Rotor identification error	- Check if the id disc is on the bottom of the rotor
E17	Communication error	- Occurs when Main and IO board are disconnected	- Contact Hanil Scientific Inc.

6. Troubleshooting

6.2 Error codes





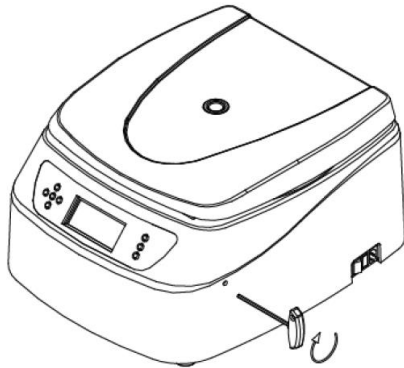



If the centrifug lid cannot be opened, you can activate the emergency open manually.

1. Turn off the power switch and wait for rotor to stop before activating the emergency open.
2. Insert the provided T-wrench into the emergency release hole and turn it clockwise until the lid is released.



7. Rotors

Fixed Angle Rotors for Fleta 4

Rotor		Tube Capacity Bottom Type	Required Adaptor	Bore Ø x L (mm) Radius (mm)	Max. RPM (rpm) Max. RCF (xg)
AL15-24  Rotor Id : 4	Hole angle : $\angle 45^\circ$ Max. Capacity : 24 x 15 mL Size (ø x H) : 164.6 x 42.8 Max. height for tube fit : 143.3 mm	 15(16) mL Round	TR15(24) 	18 x 104.5 155.8	4,000 2,789
		 15 mL Conical			
AL15-12  Rotor Id : 3	Hole angle : $\angle 45^\circ$ Max. Capacity : 12 x 15 mL Dim. ø x H : 164.6 x 42.8 mm Max. height for tube fit : 134 mm	 15(16) mL Round	TR15(12) 	18 x 94.5 142.4	4,000 2,547
		 15 mL Conical			

* Radius : From the center of the rotor to the inner end of tube carrier.

7. Rotors

Swing-out Rotors for Fleta 4

S85-4

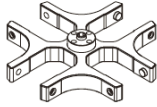

∠90°
Max. RPM : 4,000 rpm
Size (ø x H) : Ø230 x 36 mm











Bucket for S85-4



Bucket
B85

Rotor Id. : 1

Buckets and Adaptors of S85-4

Bucket	Required Adaptor	Tube Capacity Bottom Type	Tube per Adaptor / Rotor	Bore (Ø x L, mm)	Max. height for tube fit (mm)	Max. RPM (rpm) Max. RCF (xg)
 Radius(mm): 172.6 Bucket bore (ø x L, mm) : 38.5 x 88.5 Max. height for tube fit (mm) : 149.2	-	 85 mL Round	1 / 4	38.5 x 88.5	149.2	4,000 3,087
		 50 mL Round	1 / 4	29 x 95	144.2	4,000 3,001
		 50 mL Conical	1 / 4	29.5 x 100	149.2	4,000 3,087
		 15 mL Round	1 / 4	17 x 94	143.2	4,000 2,984
		 15 mL Conical	1 / 4	17 x 100	149.2	4,000 3,087

* Radius : From the center of the rotor to the inner end of tube carrier.

S50-6

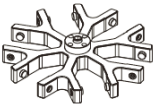

∠90°
Max. RPM : 4,000 rpm

Bucket for S50-6













Bucket
B50



Bucket
B15c-2

Rotor Id. : 2

Buckets and Adaptors of S50-6

Bucket	Required Adaptor	Tube Capacity Bottom Type	Tube per Adaptor / Rotor	Bore (Ø x L, mm)	Max. height for tube fit (mm)	Max. RPM (rpm) Max. RCF (xg)
 Radius : 181.3 mm Bucket bore (ø x L, mm) : 30.3 x 93.5 Max. height for tube fit (mm) : 145.7	-	 50 mL Round	1 / 6	30 x 93.5	145.7	4,000 3,243
		 50 mL Conical	1 / 6			
		 25 mL Round	1 / 6	20 x 87		
		 15(16) mL Round	1 / 6	18 x 87		
 Radius : 165.8 mm		 15 mL Conical	2 / 12	17 x 86.5	138.7	4,000 2,966

* Radius : From the center of the rotor to the inner end of tube carrier.

memo

memo

memo



Hanil Scientific Inc.
16 Arayukro, Gimpo 10136, Rep. of KOREA
T. 02-3452-8965
info@ihanol.com
www.ihanol.com

Doc.No.: OMF2PDEN1801